

# **BLUE MOON - PRODUCT LIST**

## **JANUARY 2014**

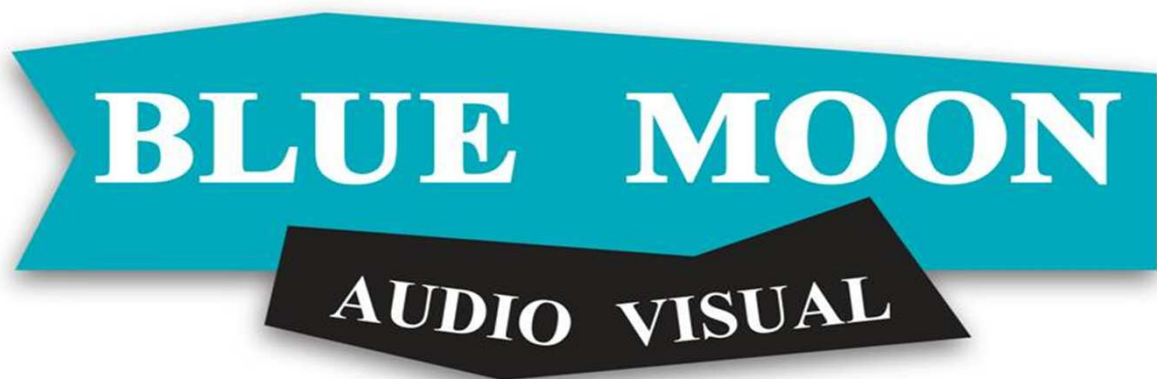

**Your partner in sound, light & video**



RCF310A



QSC K12



Bose 802III



SP3-60



SP3-15 SUB



QSC KW181

**alfacode****Product****Audio - Speakers**

AUSPK BOS802	Speaker Bose 802III
AUSPK RCF310	Speaker RCF ART310A
AUSPK EV250	Speaker Electro Voice SXA250
AUSPK SP3	Speaker Sound Projects SP3-60 top
AUSPK SP10	Speaker Sound Projects line array SP10
AUSPK 2K12	Set: 2 x Speaker QSC K12
AUSPK SP10SET	Set: 8 x Speaker Sound Projects line array SP10

**Audio - Speakers - subs**

AUSUB KW181	Speaker QSC KW181 sub
AUSUB SP3	Speaker Sound Projects SP3-15 sub
AUSUB SP4	Speaker Sound Projects SP4-15 sub

**Audio - Rigging for audio equipment**

AURFA POLQSC	Speaker pole for QSC K12
AURFA ADPOLQSC	Speaker pole for QSC K12 - adjustable
AURFA YOKK12	Yoke mount for QSC K12
AURFA MOUBOQS	All-round mount for Bose / QSC k12
AURFA SP3	Rigging bar for sp3
AURFA SP10	Rigging frame for sp10
AURFA SP10E	Rigging frame for sp10 - extension

**Audio - Amplifiers**

AUAMP 1602B	Amplifier QSC 1602 + Digital Bose controller
AUAMP RACKSP10	Amplifier rack SP10 - 3 x QSC PLX3602 + XTAdp6i

**Audio - Processors, effects & inserts**

AUPRO AR133	DI-box BSS AR-133
AUPRO FBQ	Equaliser Behringer FBQ - 31 band stereo
AUPRO MINIFX1	Mini-FX 1 (Reverb rev500 /digital eq ultracurve)
AUPRO MINIFX2	Mini-FX 2 (Reverb/4 k Gate/4 k Comp)
AUPRO ULTRA	Active signal splitter Behringer ultralink MX822
AUPRO XTA226	Processor XTA DP226i
AUPRO SP3	Driverack SP3 (dbx driverack260 + psu32)
AUPRO INT16I4O	Multi-channel audio interface Tascam US-2000 16 in / 4 out - USB interface
AUPRO LEVCON	Audio level controller Rodec
AUPRO PHANTOM	External phantom power



XTA226

Pioneer  
DJM900



SoundCraft  
MPMi



SoundCraft Si  
Expression

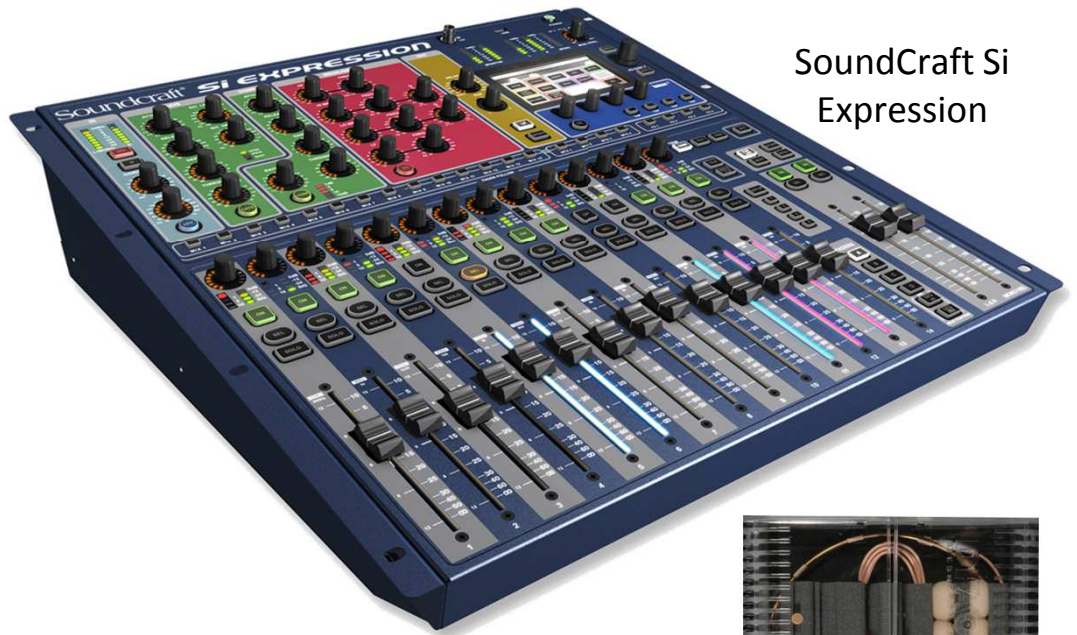

Shure SM58



Shure Beta58



Shure sm57



AKG C3000



BSS AR133



DPA 4066

## alfacode

## Product

## Audio - Consoles

AUDSK DJM800	DJ mixing console Pioneer DJM800
AUDSK DJM900	DJ mixing console Pioneer DJM900
AUDSK XEN	Mixing console Behringer Xenyx - 1mo/2st/2out
AUDSK NOTE	Mixing console Soundcraft notepad - 04mo/2st/2out
AUDSK SX	Mixing console Soundcraft MPMi - 12mo/4st/2
AUDSK O1V	Digital mixing console Yamaha O1V
AUDSK O1VEQR	EQ Rack O1V (3 x FBQ + Pioneer CMX5000)
AUDSK EXP1	Digital mixing console Soundcraft Si expression 1
AUDSK VI1	Digital mixing console Soundcraft VI1

## Audio - Stage blocks

AUSTB SOC8	Stageblock 8ch Socapex 25p
AUSTB HAR36	Stageblock 36ch harting 108p
AUSTB COMP32	Stageblock 32/8ch Soundcraft compact stageblock - optical

## Audio - Microphones

AUMIC AKC3000	Mic - AKG C3000B / condensator omni incl. clamp
AUMIC AKC414	Mic - AKG C414
AUMIC AKCK80	Mic - AKG C80 / gooseneck
AUMIC AUDP5A	Mic - Audix DP5A (K+SN+2T+FLRT) / drumkit
AUMIC AT915	Micset: - 2 x AudioTechnica ES915 + heavy base/ gooseneck
AUMIC BEB5	Mic - Behringer B5 / condensator cardio incl. clamp
AUMIC BDSTEALTH	Mic - Beyerdynamic Stealthmicro
AUMIC DP4066F	Mic - DPA 4066F / headset incl. minijack/minixlr adaptor
AUMIC NMKM184	Mic - Neumann KM184
AUMIC SEE604	Mic - Sennheiser E604 / Clip-on
AUMIC SEE845	Mic - Sennheiser E845 / handheld incl. clamp
AUMIC SEMKE40	Mic - Sennheiser MKE40-EW / lavalier
AUMIC SEHS2	Mic - Sennheiser HS2 / headset omni - Black
AUMIC SEHS2B	Mic - Sennheiser HS2 / headset omni - Beige
AUMIC SEHSP4	Mic - Sennheiser HSP4 / headset cardio
AUMIC SHSM57	Mic - Shure SM57 incl. clamp
AUMIC SHSM58	Mic - Shure SM58 incl. clamp
AUMIC SHB58	Mic - Shure Beta58 incl. clamp
AUMIC SHMX4185	Mic - Shure MX4185 / gooseneck

## Audio - Microphone - set

AUMST STATPA	Basic PA stand + cable set
AUMST MICPA	Basic PA mic set



Pioneer CDJ2000



Tascam Solid State recorder SS-R200



Sennheiser  
EW300 G3

**SENNHEISER**  
Authorized Dealer



Shure UA 870

Soundcraft  
Compact Stagebox  
(opticalcon)



Shure UR4D - UR1 - UR2



**Audio - Microphone - accessories**

AUMAC MCLS	Microphone clamp small
AUMAC MCL	Microphone clamp standard
AUMAC MTST	Microphone table stand
AUMAC MTSTA	Microphone table stand adjustable
AUMAC MST	Microphone stand standard
AUMAC MSTS	Microphone stand small
AUMAC GNB	Heavy gooseneck base with xlr

**Audio - Wireless microphones, receivers & transmitters**

AUMHF 4UR4D	Set: 4 x Shure UR4D wireless receiver H4E band + 2 flags
AUMHF UR1	Shure UR1 wireless beltpack H4E band
AUMHF UR2	Shure UR2 wireless handheld - beta58 H4E band
AUMHF SHFLAG	Shure active directional antenna UA870WB (470-900Mhz)
AUMHF EW3G2WHH	Sennheiser EW300G2 wireless handheld incl. clamp + 2 AA batt.
AUMHF EW3G2WBP	Sennheiser EW300G2 wireless beltpack incl. 2 AA batt.
AUMHF 2EW3G2WHH	Set: 2 x Sennheiser EW300G2 wireless handheld incl. 2 x clamp + 4 AA batt.
AUMHF 2EW3G2WBP	Set: 2 x Sennheiser EW300G2 wireless beltpack incl. 4 AA batt.
AUMHF 2EW3G3WBP	Set: 2 x Sennheiser EW300G3 wireless beltpack incl. 4 AA batt.
AUMHF SEFLAG	Sennheiser passive directional antenna A2003 (450-960Mhz)

**Audio - Players & recorders**

AUPLR MUL	CD player APart PC1000R / Multisource cd/usb/sd-card
AUPLR CDJ2000	CD player Pioneer CDJ2000
AUPLR CMX5000	CD player Pioneer CMX5000
AUPLR MD	Minidisc player
AUPLR SL1200	Turntable Technics SL1200
AUPLR DISCO	Discobar - Rodec MX240 + Denon D4500 MKII + Martin 2510 + mic
AUPLR SSREC	Solid state recorder Tascam SS-R200 usb/sd-card/cf-card

Conference phone



Sennheiser Tourguide



ASL Intercom



Proel speaker stand



Kenwood WT





**Audio - Communication**

AUCOM 4WT	Set: 4 x Kenwood walky Talky TK-series incl. handmic + headset
AUCOM ASLSET	ASL intercomset (master / 5 x BP / 6 x HS)
AUCOM ASLWLSET	ASL wireless intercomset (master / 4 x BP / 4 x HS)
AUCOM TOUR	Sennheiser Tourguide 2020 (20x HDE 2020-D-II-US)
AUCOM COPHO	Conference phone Polycom SoundStation VTX1000 incl mics + sub 1

**Audio - Accessories**

AUACC BOSAD	Bose stand adaptor
AUACC BGCD5	CD set with background music (5 cds)
AUACC DRPLEX	Drum plexi 168cm
AUACC HEADPH	Headphone DJ
AUACC HPDIST	Headphone distributor
AUACC XDISCO	X stand discobar
AUACC PRO	Proel speaker stand black height 1m60 max. 15kg
AUACC DBMSM2	Decibel meter SM2

**Audio - PA kits**

AUPAK REGIE	Regieset conference (12ch mixer / wireless handheld and headset 12ch mixer / wireless handheld and headset / equaliser / cd/mp3/usb-player
AUPAK MH3	PAkit Soundcraft MH3 (no monitordesk)
AUPAK VI1	PAkit Soundcraft VI1 (8 monitors) no monitordesk



Multipar



LED sphere



ETC zoom



ETC junior



octostrips



Spectral M800

**Light - Projectors**

LIPRO 4BP30SET	Set: 3 x Fourbar 4 x par30 no clamps
LIPRO 4BP56	Fourbar 4 x par56
LIPRO 4BP64	Fourbar 4 x par64 - CP86 VNSP
LIPRO 4BMUL	Fourbar 4 x multipar
LIPRO DISP	Spot 050W - display hallogen
LIPRO P30	Spot 070W - par30 silver
LIPRO D120	Spot 120W - deco120 uplighter
LIPRO P64BSFC	Spot 500W - par64 floorcan (black short)
LIPRO MUL	Spot 575W - multipar (solo)
LIPRO CYCA	Spot 1kW - cyclo assymm
LIPRO CYCS	Spot 1kW - cyclo symm
LIPRO C101	Spot PC 1kW - ADB C101 + barndoor
LIPRO C201	Spot PC 2kW - ADB C201 + barndoor
LIPRO SP10	Spot Fresnel 1kW - ADB SP10 pole operated
LIPRO SP20	Spot Fresnel 2kW - ADB SP20 pole operated

**Light - Profiles & follow spots**

LIPRF ETCJR	ETC profile junior 575W (25-50)
LIPRF ETCMAX	ETC profile maxi 750W (25-50)
LIPRF DS205	ADB profile DS205 2kw (15-36)
LIPRF FS1200	Follow spot 1200W HMI

**Light - LED lights**

LILED OCTO8	Set: 8 x Showtec octostrip + controller
LILED M800SET	Set: 6 x Spectral M800 ledspot + controller incl. dmxmulti 6x10m + 3x1m
LILED 4BM800	Fourbar 4 x M800 ledspot
LILED SPHCON	LED controller voor led sphere 50cm
LILED SPH50	LED sphere 50cm



Mac550



Mac250



ROBE 600



GLP 120RZ



GLP X4



Atomic 3000



Studio  
Beam



sunstrip

**Light - Intelligent lights**

LIINT MAC250	Movinghead Martin MAC 250 Entour spotlight
LIINT MAC250B	Movinghead Martin MAC 250 beam
LIINT MAC550	Movinghead Martin MAC 550 Spotlight
LIINT MAC575K	Movinghead Martin MAC 575 Krypton
LIINT GLPI120	Movinghead GLP Impression 120RZ
LIINT GLPIX4	Movinghead GLP Impression X4
LIINT ROBLB100	Movinghead Robe Ledbeam 100
LIINT ROB600	Movinghead Robe ROBIN 600 Ledwash
LIINT CC2500	Citycolor Studio Due CCIP54 2500W
LIINT MCC	Mini citycolor 150W
LIINT SUN8	Set: 8 x Showtec Sunstrip

**Light - Discharge lamps**

LIDIS STB150	Spot 150W - Studio Beam Black 3.000K
LIDIS HQIS	Spot 400W - HQI SYM 4.200K
LIDIS HQIA	Spot 400W - HQI AS 4.200K

**Light - Lighting effects**

LIEFF LC25	Set: Lightcone 2,5m
LIEFF LC40	Set: Lightcone 4m
LIEFF GLN20	Guirlande white l=20m
LIEFF GLNC05	Guirlande colours l=5
LIEFF GLNC10	Guirlande colours l=10
LIEFF GLNC20	Guirlande colours l=20
LIEFF MB20	Mirror ball 20 cm
LIEFF MB30	Mirror ball 30cm
LIEFF MB50	Mirror ball 50cm
LIEFF MBMOTOR	Mirror ball motor
LIEFF ATO	Lighteffect - Martin Atomic 3000 DMX
LIEFF LL	Lighteffect - Loungelaser
LIEFF BLG400	Lighteffect - Blacklite gun 400W

**Light - Dimmers**

LIDIM 32A	Dimmer 6 channel 6 x 3,3kw - 32A in
LIDIM SP12	Dimmer 12 channel Lighttec SP12 12 x 2kw - 63A in
LIDIM 4CH	Dimmer 4 channel shucko



Light Jockey 2



grand MA Light



SDS-06



Magnum hazer



CityColor 2500



Lighttec SP12



VICount compact hazer

**Light - Light controllers**

LICON REC	Light controller Martin dmx-recorder
LICON DETO	Light controller Detonator
LICON GMAL	Light controller GrandMA Light
LICON GMA2L	Light controller GrandMA 2 Light
LICON LIJO	Light controller Martin lightjockey II USB-unit + laptop
LICON 2510	Light controller Martin 2510 controller
LICON 2518	Light controller Martin 2518 controller
LICON LEDC	Light controller Showtec led commander
LICON SCENE	Light controller Showtec scene pilot
LICON SDS	Light controller Showtec sds-6 channel mixer
LICON Z88XL	Light controller Zero88 xls - 24 channel
LICON TTL3	Light controller TTL Princess v3

**Light - Foggers and fans**

LIFOG ZR33	Jem ZR33 Smoke machine incl. oil
LIFOG MAGNUM	Martin Magnum Hazer incl. oil
LIFOG VICOUNT	Vicount compact hazer incl. oil and CO2
LIFOG FAN	Fan for hazer - 40cm

**Light - Accessories**

LIACC KS485	DMX splitter / booster - Martin RS 485
LIACC OPTO	DMX splitter / booster - Optobranh
LIACC DDBT	DMX splitter / booster - 2 dmx booster truss
LIACC DMXDDB	DMX splitter / booster - 19inch double dmx booster 2 in and 6 out on XLR3 and 6 out on XLR5 pin
LIACC DOME	Outdoor dome for movinghead



LCD 2000



DLP 3500



DLP 6000



DLP 7000



DLP 10.000



**Video - Projectors**

VIPRJ LCD02K	Projector Panasonic - LCD 2000 lumen / XGA
VIPRJ DLP04K	Projector Panasonic D3500 - DLP 3500 lumen / XGA incl. std lens: 1.8 -2.5
VIPRJ DLP06K	Projector Panasonic D5700 - DLP 6000 lumen / XGA incl. std lens: 1.8 -2.5
VIPRJ DLP10K	Projector Panasonic DS100 - DLP 10.000 lumen / SXGA+ incl. frame - without lens
VIPRJ HD20	Projector Barco FLMHD20 - DLP 18.000 lumen / Full HD incl. frame - without lens
VIPRJ DLP07K	Projector Panasonic DZ770 - DLP 7.000 lumen / WUXGA incl. frame - without lens
VIPRJ DLP20K	Projector Panasonic DZ21EK - DLP 20.000 lumen / WUXGA incl. frame - without lens

**Video - Projector accessories**

VIPAC PLAT	Projector platform for speaker stand small
VIPAC PLATBIG	Projector platform for speaker stand large
VIPAC PRPLATF	Projector platform for Manfrotto wind-up small
VIPAC PRPLATFBIG	Projector platform for Manfrotto wind-up large
VIPAC FRAMES	Projector frame small - 2000L - 3500L
VIPAC FRAMEM	Projector frame medium - 6000L
VIPAC FRAMEL	Projector frame large - 10.000L - 15.000L
VIPAC STACK	Projector frame large - 10.000L - 15.000L (stacking)
VIPAC LPXSHORT	Projectorlens Panasonic ET-DLE050 - extra short 0.8
VIPAC LPSHORTZ	Projectorlens Panasonic ET-DLE100 - short zoom 1.3 - 1.8
VIPAC LPMIDLONG	Projectorlens Panasonic ET-DLE200 - midlong zoom 2.5 - 4.0
VIPAC LPLONG	Projectorlens Panasonic ET-DLE310 - long zoom 3.4 - 4.5
VIPAC LPTELEZ	Projectorlens Panasonic ET-DLE410 - tele zoom 4.5 - 8.2
VIPAC LD75XS	Projectorlens Panasonic ET-D75LE50 - extra short 0.8 4:3 : 0.8 // 16:9 : 0.8 // 16:10 : 0.7
VIPAC LD75SZ	Projectorlens Panasonic ET-D75LE10 - short zoom 1.4-1.8 4:3 : 1.4-1.8 // 16:9 : 1.4-1.9 // 16:10 : 1.3-1.7
VIPAC LD75STDZ	Projectorlens Panasonic ET-D75LE20 - standard zoom 1.8-2.6 4:3 : 1.8-2.6 // 16:9 : 1.8-2.7 // 16:10 : 1.7-2.4
VIPAC LD75MLZ	Projectorlens Panasonic ET-D75LE30 - midlong zoom 2.6-5.1 4:3 : 2.6-5.1 // 16:9 : 2.7-5.2 // 16:10 : 2.4-4.7
VIPAC LD75LZ	Projectorlens Panasonic ET-D75LE40 - long zoom 5.0-8.0 4:3 : 5.0-8.0 // 16:9 : 5.1-8.2 // 16:10 : 4.6-7.4
VIPAC LD75TZ	Projectorlens Panasonic ET-D75LE8 - tele zoom 7.9-15.0 4:3 : 7.9-15.0 // 16:9 : 8.2-15.4 // 16:10 : 7.3-13.8
VIPAC LBXSHORT	Projectorlens Barco - extra short 0.8
VIPAC LBSHOZO	Projectorlens Barco - short zoom 1.6-2.0
VIPAC LBSTD	Projectorlens Barco - standard zoom 2.0 - 2.8
VIPAC LBMIDLONG	Projectorlens Barco - midlong zoom 2.8-5.0
VIPAC LBLONG	Projectorlens Barco - long zoom 5.0-8.0
VIPAC LBTELE	Projectorlens Barco - tele zoom 7.5-15



Plasma 65inch Full HD



Litescreen



Plasma 42inch Full HD



LCDLED 40inch Full HD



Fastfold screen



TFT 19inch

**Video - Projection screen**

VISCR 240X180	Projection screen Projecta 240x180 - 4:3 Front + retro
VISCR 305X229	Projection screen Screenworks 305x229 - 4:3 Front + retro / Net area 295 x 218
VISCR 457X351	Projection screen Screenworks 457x351 - 4:3 Front + retro / Net area 427x320
VISCR 600X450	Projection screen Projecta 600x450 - 4:3 Front + retro
VISCR 290X173	Projection screen Screenworks 290x173 - 16:9 Front + retro / Net area 269x152
VISCR 427X259	Projection screen Screenworks 427x259 - 16:9 Front + retro / Net area 396 x 229
VISCR 678x396	Projection screen Screenworks 678x396 - 16:9 Front + retro / Net area 648x360
VISCR 838X488	Projection screen Screenworks 838x488 - 16:9 Front + retro / Net area 808x457
VISCR VS400X300	Velcroscreen 400x300 - 4:3 Borderless front projection
VISCR VS400X225	Velcroscreen 400x225 - 16:9 Borderless front projection
VISCR LIT	Litescreen Delux 211x160 Front / Net area 203 x 152

**Video - Displays**

VIDIS TFT19	TFT screen 19 inch Neovo
VIDIS TFT23	TFT screen 23 inch Dell / Full HD
VIDIS LED40	LED screen 40 inch Samsung me40 / Full HD
VIDIS LED65	LED screen 65 inch Samsung me65b / Full HD
VIDIS PLASMA42	Plasmascreen 42 inch Panasonic TH-42PF20ER / Full HD
VIDIS PLASMA50	Plasmascreen 50 inch Pioneer PDP-50MXE20 without speakers
VIDIS PLASMA65	Plasmascreen 65 inch Panasonic TH-65PF10EK / Full HD incl. speakers
VIDIS PLASMA103	Plasmascreen 103 inch Panasonic TH-103PF12EK / Full HD

**Video - Audio for displays**

VIAUD PL50	Speakerset for plasmascreen pioneer 50"
VIAUD PL65	Speakerset for plasmascreen panasonic 65"



Tascam DVD player

Gefen - DVI splitter 1:4



Extron - RGBHV splitter 1:6

AJA KIPRO



Folsom - ImagePro 3G



Analog Way - Diventix II



Neutrik - Opticalcon



**Video - Signal processing**

VISPR XGA4	Switcher XGA 4
VISPR DVS	Switcher/scaler - Extron DVS 406
VISPR USP	Switcher/scaler - Extron USP 405
VISPR IMGPRO	Switcher/scaler - Folsom Imagepro 3G
VISPR MGP	Seamless switcher/scaler - Extron MGP 462
VISPR PDS902	Seamless switcher/scaler - Folsom PDS902
VISPR DIVII	Seamless switcher/scaler - Analog Way Diventix II
VISPR MS1000	Mobile Video Studio Datavideo MS-1000 / HD-SDI
VISPR EMSX4	EMS Xtreme4vs video wall controller

**Video - Distribution amplifiers**

VIDAM SDI4	Distribution amp. hdsdi 1:4 / AJA HD5DA
VIDAM SDI6	Distribution amp. hdsdi 1:6 (reclocker) / AJA HD10DA
VIDAM DVIHD4	Distribution amp. DVI 1:4 1920x1080
VIDAM RGBHV6	Distribution amp. RGBHV 1:6
VIDAM RGBHV2	Distribution amp. RGBHV 1:2
VIDAM XGA2	Distribution amp. XGA 1:2
VIDAM VIDAMHDMI1	HDMI repeater 1:1

**Video - Convertors**

VICON HI5	Convertor hdsdi/sdi -> hdmi + hdsdi link / AJAHI5
VICON HD10AMA	Convertor hdsdi/sdi 4ch audio embedder / AJA HD10AMA
VICON VC880	Convertor hdmi audio de-embedder + hdmilink / Aten VC880
VICON DVIEXT	Neutrik opticalcon DVI extender

**Video - Video sources & recorders**

VISRC DVDCON	DVD player consumer - Pioneer/Sony
VISRC DVDPRO	DVD player pro - Tascam DV-D01U
VISRC BLURAY	Blue-ray player - Samsung BD-E5500 -- hdmi only!
VISRC HDDREC	Hard disk recorder Sony / DVD writer
VISRC HDRKIPRO	Hard disk recorder AJA KI PRO
VISRC PTCAM	Video camera Panasonic AW-HS50E pan-tilt camera / HDSDI
VISRC PTCON	Video camera Panasonic AW-RP50 pan-tilt controller up to 100 cams
VISRC EX1	Video camera Sony PMW EX1 / HDSDI incl. spare batt. + 8GB/32GB mem card
VISRC TRIP	Manfrotto Video Tripod 503HDV/525PKIT
VISRC DVDCOP	DVD disc copy
VISRC DVDMAS	DVD disc master

**Video - IT**

VIICT SWITCH	8-port ethernet switch 10/100 Mbps
VIICT LAPTOP	PC Laptop HP
VIICT HD	Portable USB hard-disk incl. verzending naar klant
VIICT APTV	Apple TV



Dsan - Perfect Cue



AJA convertors



Sony EX1



Videowall controller



DataVideo MS-1000

**Video - Accessories**

VIACC PLASMA	<b>Design stand plasmascreen</b> height = 2m00
VIACC LED	<b>Design stand ledscreen small</b>
VIACC LASHE	<b>Laptop shelf</b>
VIACC POINTER	<b>Laser pointer</b>
VIACC CUE	<b>Dsan perfect cue - cuelight with laserpointer</b>
VIACC STGSTAND	<b>Plasmascreen stage stand</b>
VIACC STGSTANDS	<b>Plasmascreen stage stand small</b>
VIACC PSBRACK	<b>Plasmascreen truss/stand bracket</b>
VIACC RFKIT	<b>DVB-T TV kit - hdmi</b>
VIACC RFKITCOMP	<b>DVB-T TV kit - composite</b>
VIACC SATANT	<b>Satellite dish antenna kit (antenna + decoder)</b> EXCL. operator subscription!
VIACC DL	<b>Desklight</b> Regielampje

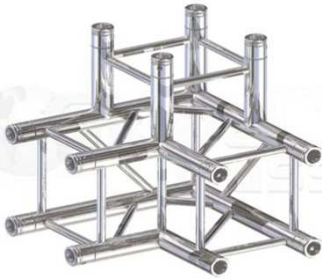

F34 - C3W90

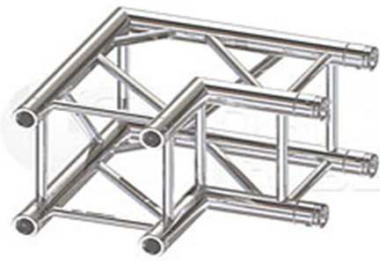

F34 - C2W90

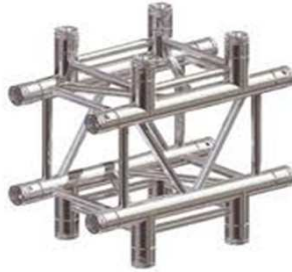

F34 - C4WC



F34 - C3WT

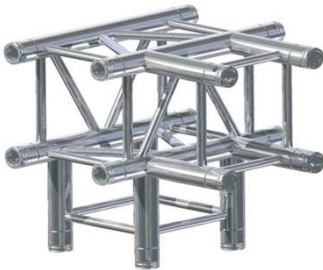

F34 - C4WT



F34 section



F34 section

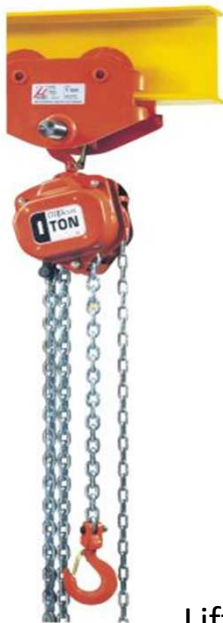

Liftikus  
manual hoist



Stagemaker  
SM5

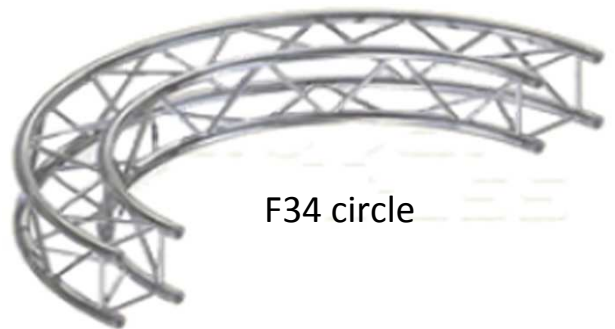

F34 circle



**Rigging - Globaltruss F34**

RIF34 C2W90	Globaltruss F34 2-way 90
RIF34 C3W90	Globaltruss F34 3-way 90
RIF34 C3WT	Globaltruss F34 3-way T-Stuk
RIF34 C4WC	Globaltruss F34 4-way cross
RIF34 C4WT	Globaltruss F34 4-way T-stuk
RIF34 L025	Globaltruss F34 l=0,25m
RIF34 L050	Globaltruss F34 l=0,5m
RIF34 L100	Globaltruss F34 l=1m
RIF34 L150	Globaltruss F34 l=1,5m
RIF34 L200	Globaltruss F34 l=2m
RIF34 L250	Globaltruss F34 l=2,5m
RIF34 L300	Globaltruss F34 l=3m
RIF34 L400	Globaltruss F34 l=4m
RIF34 CID3	Globaltruss F34 circle 3m
RIF34 CID4	Globaltruss F34 circle 4m

**Rigging - Globaltruss F32**

RIF32 C90	Globaltruss F32 ladder 2-way 90
RIF32 L050	Globaltruss F32 ladder l=0,5m
RIF32 L100	Globaltruss F32 ladder l=1m
RIF32 L150	Globaltruss F32 ladder l=1,5m
RIF32 L200	Globaltruss F32 ladder l=2m
RIF32 L250	Globaltruss F32 ladder l=2,5m
RIF32 L300	Globaltruss F32 ladder l=3m

**Rigging - Alu pipes**

RIAPI 100	Alu pipe L=1m
RIAPI 150	Alu pipe L=1,5m
RIAPI 200	Alu pipe L=2m
RIAPI 250	Alu pipe L=2,5m
RIAPI 300	Alu pipe L=3m

**Rigging - Hoists**

RIHST MAN	Manual hoist - 500kg - chain 10m
RIHST SM5	Motorhoist Verlinde SM5 - 500kg - chain 20m
RIHST SM10	Motorhoist Verlinde SM10 - 1.000kg - chain 20m
RIHST CV1	Hoist controller V1
RIHST CV4	Hoist controller V4
RIHST CV8	Hoist controller V8



Softsteel



F34 cornerblock



F34 spacer



trussclamp



C - clamp



trigger clamp



double trussclamp



spigot  
29mm

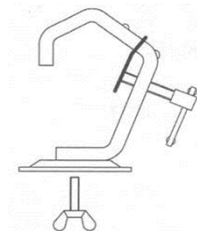

ADB A25

## alfacode

## Product

**Rigging - Steels**

RISTL HARP100	Crosby harp - shackle 1 ton
RISTL HARP	Crosby harp - shackle 3,5ton
RISTL HARP475	Crosby harp - shackle 4,75 ton - black
RISTL RS100	Roundsling 1 ton l=1m
RISTL RS150	Roundsling 1 ton l=1.5m
RISTL RS200	Roundsling 1 ton l=2m
RISTL RS300	Roundsling 1 ton l=3m
RISTL SS100	Softsteel 2 ton l=1m
RISTL SS160	Softsteel 2 ton l=1.6m
RISTL SS200	Softsteel 2 ton l=2m
RISTL SS300	Softsteel 2 ton l=3m
RISTL ST200	Steel 1 ton plastified l=2m
RISTL ST300	Steel 1 ton plastified l=3m
RISTL SAF050	Safety steel 50cm
RISTL SAF075	Safety steel 75cm
RISTL LAST02	Lashing strap for all-round mount 2m Without hooks
RISTL LASTHOOK	Lashing strap hooks With hooks

**Rigging - Globaltruss accessories**

RIGAC 100PC	Globaltruss F34 case with 100 pin/clips
RIGAC CPL	Globaltruss F34 coupler
RIGAC MFTA	Globaltruss F34 Manfrotto truss adaptor
RIGAC SBF	Globaltruss F34 baseplate small female
RIGAC SBM	Globaltruss F34 baseplate small male
RIGAC HBP	Globaltruss F34 half baseplate heavy 50x80
RIGAC ABP	Globaltruss F34 baseplate aluminium 100x100
RIGAC CB	Globaltruss F34 cornerblock (incl. 24 half-couplers)
RIGAC CB10P	Globaltruss F34 truss spacer 10 cm
RIGAC CB20P	Globaltruss F34 truss spacer 20 cm
RIGAC HACO	Globaltruss F34 half cone

**Rigging - Clamps**

RICLM TCD	Double truss clamp swl 500kg
RICLM THOM	C-clamp swl 50kg
RICLM ADB	ADB clamp
RICLM TCS	Single truss clamp swl 500kg
RICLM TRIG	Trigger clamp swl 250kg
RICLM SPIG	Standard spigot 29mm
RICLM TENT	Tentclamp
RICLM BEAM	Beamclamp swl 1 ton

ALP lift

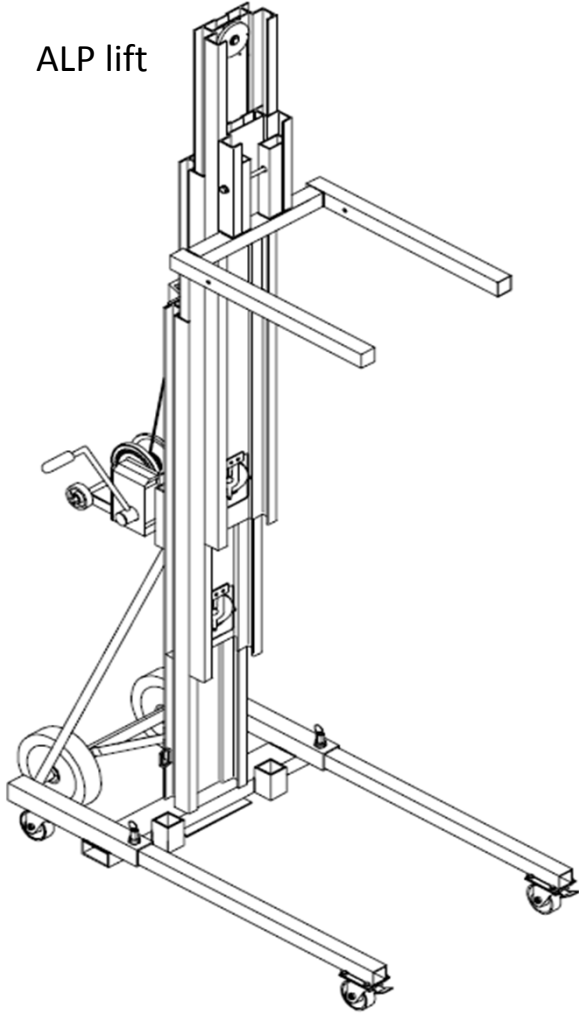

Manfrotto



VMB

## alfacode

## Product

**Rigging - Stands & wind-ups**

RISTA LIGHT	Fourbar stand
RISTA PVM	PVM stand - 1m50
RISTA MAN	Wind-up Manfrotto height 3m80 max. 35kg
RISTA MANX	Wind-up Manfrotto extension
RISTA VMB	Wind-up VMB height 1m70 - 5m30 max. 100kg
RISTA ALP475	Wind-up Alp 475 height 4m75 max. 250kg
RISTA ALP600	Wind-up Alp 600 height 6m00 max. 250kg
RISTA ALP750	Wind-up Alp 750 height 7m50 max. 300kg
RISTA FX650	Wind-up Fenix alu lift 6,5m 1.76m folded - max. 250kg
RISTA FX800	Wind-up Fenix alu lift 8.0m 1.98m folded - max. 300kg
RISTA ALC1050	ALC speaker tower h=10.5m load = max. 1000kg / hoist not included

**Rigging - Skyworkers**

RISKY LADDER	Ladder Altrex mounter length: / 2m30 - 5m50 - \ 4m50
RISKY SCA2	Scaffolding working height 2m
RISKY SCA5	Scaffolding working height 5m
RISKY PHC1100	Personal lift ALP PHC1100 - working height 11m
RISKY PHC1300	Personal lift ALP PHC1300 - working height 12.7m
RISKY SAFHA	Safety harness

**Electricity - Power supply units**

ELPSU 16DIBO	Distrobox 16A circuit breaker (out: 3 x shucko)
ELPSU 16	Distrobox CEE 16A (out: 3 x shucko - no circuit breaker)
ELPSU 32A	Power supply unit CEE 32A (out: 12 x shucko)
ELPSU 32B	Power supply unit CEE 32A (out: 16A + H16p + 6xshucko)
ELPSU 63A	Power supply unit CEE 63A (out: 2x32A+2x16A)
ELPSU 63B	Power supply unit CEE 63A (out: 1x63A + 2x32A + 2x16A + 3xshucko)
ELPSU 63C	Power supply unit CEE 63A (out: 4 x 32A)
ELPSU 125B	Power supply unit CEE 125A (out: 3 x 63A)
ELPSU 125A	Power supply unit CEE 125A (out: 4 x 63A)
ELPSU 125H	Power supply unit CEE 125A (out: 6 x H16p. + 8 x CEE16M)

**Electricity - Accessories**

ELACC CIRBR32	Circuit breaker 32A
---------------	---------------------

## alfacode

## Product

**Staging - Stages**

STSTG EL1	Stage element Butec 1m x 1m
STSTG EL2	Stage element Butec 2m x 1m
STSTG ELR2	Stage round d=2m
STSTG LEGS020	Stage legset 4 x 20 cm stage height = 20cm
STSTG LEGS030	Stage legset 4 x 30 cm stage height = 30cm
STSTG LEGS040	Stage legset 4 x 40 cm stage height = 20cm
STSTG LEGS060	Stage legset 4 x 60 cm stage height = 60cm
STSTG LEGS075	Stage legset 4 x 75 cm stage height = 75cm
STSTG LEGS090	Stage legset 4 x 90 cm stage height = 90cm
STSTG LEGS115	Stage legset 4 x 115 cm stage height = 115cm
STSTG LEGS120	Stage legset 4 x 120 cm stage height = 120cm
STSTG SKIRT030	Stage skirt black 6m x 30cm
STSTG SKIRT060	Stage skirt black 6m x 60cm
STSTG SKIRT090	Stage skirt black 6m x 90cm
STSTG SKIRT120	Stage skirt black 6m x 120cm
STSTG SKIRT150	Stage skirt black 3m x 150cm regiedoek
STSTG CARPET1X1	Stage carpet dark grey 4899X - 1mx1m
STSTG CARPET2X1	Stage carpet dark grey 4899X - 2mx1m
STSTG CARPET2X2	Stage carpet dark grey 4899X - 2mx2m
STSTG CARPET2X3	Stage carpet dark grey 4899X - 2mx3m
STSTG CARPET2X4	Stage carpet dark grey 4899X - 2mx4m
STSTG CARPET2X5	Stage carpet dark grey 4899X - 2mx5m
STSTG CARPET2X6	Stage carpet dark grey 4899X - 2mx6m

**Staging - Stage accessories**

STSTA STAIRS	Stage stairs for 60/90
STSTA RR1	Rolling riser - stage leg adaptor 1 leg
STSTA RR2	Rolling riser - stage leg adaptor 2 legs
STSTA RR4	Rolling riser - stage leg adaptor 4 legs

**Staging - Backdrops black**

STBBL H50B300	Backdrop molton black - H500 B300
STBBL DISCO	Backdrop molton black - disco bar
STBBL PVM	Backdrop molton black - PVM
STBBL H25B244	Backdrop molton black H250 B244 - fond
STBBL H25B305	Backdrop molton black H250 B305 - fond
STBBL H25B427	Backdrop molton black H250 B427 - fond
STBBL H25B653	Backdrop molton black H250 B653 - fond
STBBL REGIE	Backdrop molton black - regie

**Staging - Backdrops night blue**

STBNB CSH53B300	Backdrop molton CS night blue H530 B300
STBNB CSH53B600	Backdrop molton CS night blue H530 B600
STBNB CSH06B250	Backdrop molton CS night blue H60 B250 - fries
STBNB CSH06B435	Backdrop molton CS night blue H60 B435 - fries
STBNB CSH25B264	Backdrop molton CS night blue H250 B264 - fond
STBNB CSH25B447	Backdrop molton CS night blue H250 B447 - fond

**Staging - Backdrop accessories**

STBAC TUBE1	Backdrop verzwarringsbuis (21,5mm)
STBAC TUBE2	Backdrop verzwarringsbuis (47mm)
STBAC CLAMPM	Backdrop clamp mini
STBAC CLAMPS	Backdrop clamp small
STBAC CLAMPL	Backdrop clamp large
STBAC TRACK	Eurotrack railsysteem /lm

**Staging - Voiles**

STVOI DTFH30B600	Voile decotaft white H300 B600 (met loodverzwaring)
------------------	---

**Staging - Pipe & drape**

STPPD BL300	Pipe & drape black h=3m /lm
STPPD BL400	Pipe & drape black h=4m /lm

**Staging - Scenery**

STSCE DEPAS4	Deco panel small for 4 x octostrip
STSCE DEPAB8	Deco panel big for 8 x octostrip
STSCE DEPAL16	Deco panel long for 16 x octostrip
STSCE DEDJBO	Design DJ booth - small
STSCE DEDJBOL	Design DJ booth - large
STSCE TRISHDJ	Triangular shelf DJ-booth
STSCE REGDSK	Regie desk with facures
STSCE STDLECT	Standard lectern
STSCE DESLECT	Design lectern with built-in led lighting
STSCE LOGO	Personalised company logo on lectern
STSCE WHITEB	Whiteboard 2m x 1m
STSCE FLIP	Flipchart incl. paper ** EXCL MARKERS
STSCE PAPER	Flipchart paper - new rol

**alfacode****Product****Staging - Consumables**

STCON GAFFAG	Gaffa-tape grey - 50mm x 50m
STCON GAFFAW	Gaffa-tape white - 50mm x 50m
STCON GAFFAB	Gaffa-tape black - 50mm x 50m
STCON DBL	Dubbel sided tape (for stage carpet) - 50mm x 50m
STCON HAZFL	Hazer pro fluid
STCON SMKFL	Smoke pro super fluid
STCON CARPFOIL	Stage carpet rol 30m x 2m - with protection foil
STCON SLVW	Truss sleeve white (/ m)



**Cables - Cablekits**

CAKIT DMX3	<b>Cablekit dmx 3pin</b> 20 x 3m, 20 x 5m, 20 x 10m, 10 x 20m
CAKIT DMX5	<b>Cablekit dmx 5pin</b> 20 x 3m, 20 x 5m, 20 x 10m, 10 x 20m
CAKIT HAR2	<b>Cablekit harting 16p. - 10 x 20m</b> 10 x 20m
CAKIT HAR1	<b>Cablekit harting 16p. - 10 x 5m, 10m x 10m</b> 10 x 5m, 10 x 10m
CAKIT RIGG	<b>Cablekit rigging</b>
CAKIT SHUCKO	<b>Cablekit shucko</b> 15 x domino, 15 x 5m, 15 x 10m, 15 x 15m, 5 x 25m
CAKIT SP3	<b>Cablekit SP3</b>
CAKIT SP10	<b>Cablekit SP10</b>

**Cables - Shucko**

CASHU 15C02	<b>Cable shucko 1,5c l=2m</b>
CASHU 15C05	<b>Cable shucko 1,5c l=5m</b>
CASHU 15C10	<b>Cable shucko 1,5c l=10m</b>
CASHU 15C15	<b>Cable shucko 1,5c l=15m</b>
CASHU 25C25	<b>Cable shucko 2,5c l=25m</b>
CASHU 25C15	<b>Cable shucko 2,5c l=15m</b>

**Cables - Signal**

CASIG JJTRS	<b>Cable signal jack TRS</b>
CASIG JACK	<b>Cable signal jack</b>
CASIG MJ	<b>Cable signal minijack</b>
CASIG CIN10	<b>Cable signal cinch l=10m</b>
CASIG XCIN02	<b>Cable signal cinch extension l=2m</b>
CASIG XCIN10	<b>Cable signal cinch extension l=10m</b>
CASIG 5P05	<b>Cable signal dmx 5pin l=5m</b>
CASIG 5P15	<b>Cable signal dmx 5pin l=15m</b>
CASIG UTP02	<b>Cable signal utp cable l=2m</b>
CASIG UTP05	<b>Cable signal utp cable l=5m</b>
CASIG UTP10	<b>Cable signal utp cable l=10m</b>
CASIG UTPM	<b>Cable signal utp cable (verkoop / m)</b>
CASIG XLR01	<b>Cable signal xlr l=1m</b>
CASIG XLR02	<b>Cable signal xlr l=2m</b>
CASIG XLR05	<b>Cable signal xlr l=5m</b>
CASIG XLR10	<b>Cable signal xlr l=10m</b>
CASIG XLR15	<b>Cable signal xlr l=15m</b>
CASIG XLR100	<b>Cable signal xlr l=100m / haspel</b> unisex connectors

## alfacode

## Product

**Cables - Adaptor signal**

CAASI 2CM2XF	Cable adaptor 2 x cinch (m) -> 2 x xlr (f)
CAASI 2CM2XM	Cable adaptor 2 x cinch (m) -> 2 x xlr (m)
CAASI 2CM1XF	Cable adaptor 2 x cinch (m) -> xlr (f)
CAASI 2CM1XM	Cable adaptor 2 x cinch (m) -> xlr (m)
CAASI 2JM2CM	Cable adaptor 2 x jack (m) -> 2 x cinch (m)
CAASI 2JM2XF	Cable adaptor 2 x jack (m) -> 2 x xlr (f)
CAASI 2JM2XM	Cable adaptor 2 x jack (m) -> 2 x xlr (m)
CAASI 1CF1BM	Cable adaptor cinch (f) -> bnc (m)
CAASI CPLCINCH	Cable adaptor cinch (f) -> cinch (f)
CAASI 1CF1XF	Cable adaptor cinch (f) -> xlr (f)
CAASI 1CF1XM	Cable adaptor cinch (f) -> xlr (m)
CAASI 1CM2CF	Cable adaptor cinch (m) -> 2 x cinch (f)
CAASI 1CM1XF	Cable adaptor cinch (m) -> xlr (f)
CAASI 1CM1XM	Cable adaptor cinch (m) -> xlr (m)
CAASI CIJA	Cable adaptor cinch -> jack
CAASI 1JF1XM	Cable adaptor jack (f) -> xlr (m)
CAASI 1JM1CM	Cable adaptor jack (m) -> cinch (m)
CAASI 1JM1XF	Cable adaptor jack (m) -> xlr (f)
CAASI 1JM1XM	Cable adaptor jack (m) -> xlr (m)
CAASI 1MJM1CM	Cable adaptor minijack (m) -> cinch (m)
CAASI 1MJM1X	Cable adaptor minijack (m) -> xlr
CAASI 1MJM2JM	Cable adaptor minijack (m) - 2 x jack (m)
CAASI 1XF2XM	Cable adaptor xlr (f) -> 2 x xlr (m) / split
CAASI CPLXLRf	Cable adaptor xlr (f) -> xlr (f) / gender
CAASI CPLXLrM	Cable adaptor xlr (m) - xlr (m) / gender
CAASI 1XM2XF	Cable adaptor xlr (m) -> 2 x xlr (f) / split
CAASI XLRINV	Cable adaptor xlr invers
CAASI ZSPL	Cable adaptor xlr Z-split

**Cables - Speaker**

CASPK NL205	Cable speaker speakon 2 p. l=5m
CASPK NL210	Cable speaker speakon 2 p. l=10m
CASPK NL215	Cable speaker speakon 2 p. l=15m
CASPK NL220	Cable speaker speakon 2 p. l=20m
CASPK NL402	Cable speaker speakon 4 p. l=2m
CASPK NL410	Cable speaker speakon 4 p. l=10m
CASPK NL8002	Cable speaker speakon 8 p. l=0.2m
CASPK NL810	Cable speaker speakon 8 p. l=10m
CASPK NL815	Cable speaker speakon 8 p. l=15m
CASPK NL825	Cable speaker speakon 8 p. l=25m

**Cables - Adaptor other**

CAADA CPLNL4	Cable adaptor speakon nl4 coupler
CAADA CPLNL8	Cable adaptor speakon nl8 coupler
CAADA XLRNL2	Cable adaptor xlr (m) -> speakon
CAADA EURO	Cable adaptor shucko (m) -> eurostroom (f) l=1m
CAADA EURO5	Cable adaptor shucko (m) -> eurostroom (f) l=5m
CAADA PWRC	Cable adaptor shucko (m) -> powercon blue
CAADA BLK	Cable adaptor shucko (m) -> 4 x shucko (f) / domino
CAADA 16ABLK10	Cable adaptor CEE 16A (m) -> 4 x shucko (f) / domino l=10m
CAADA 16ABLK15	Cable adaptor CEE 16A (m) -> 4 x shucko (f) / domino l=15m
CAADA DMX3P5P	Cable adaptor dmx 3 pin - dmx 5 pin
CAADA DMX5P3P	Cable adaptor dmx 5 pin - dmx 3 pin
CAADA DMXSTOP	DMX Stop
CAADA POWCOU	Cable adaptor powercon coupler

**Cables - Signal video**

CASVI SDI02	Cable signal SDI l=2m
CASVI SDI25	Cable signal bnc HD-SDI l=25m
CASVI SDI100	Cable signal bnc HD-SDI l=100m / haspel
CASVI BNC02	Cable signal bnc l=2m
CASVI BNC05	Cable signal bnc l=5m
CASVI BNC10	Cable signal bnc l=10m
CASVI BNC15	Cable signal bnc l=15m
CASVI BNC20	Cable signal bnc l=20m
CASVI DVI02	Cable signal dvi l=2m
CASVI DVI10	Cable signal dvi l=10m
CASVI HDMI10	Cable signal hdmi l=10m
CASVI OPTICCPL	Cable signal opticalcon duo coupler multimode / koppelbus
CASVI OPTIC100	Cable signal opticalcon neutrik l=100m / haspel
CASVI VGA02	Cable signal vga l=2m
CASVI VGA05	Cable signal vga l=5m
CASVI VGA10	Cable signal vga l=10m
CASVI VGA15	Cable signal vga l=15m
CASVI VGA25	Cable signal vga l=25m
CASVI XVGA02	Cable signal vga extention l=2
CASVI XVGA05	Cable signal vga extention l=5m
CASVI XVGA10	Cable signal vga extention l=10m
CASVI XVGA15	Cable signal vga extention l=15m
CASVI XVGA25	Cable signal vga extention l=25m

## Cables - Adaptor video

CAAVI CPLBNC	Cable adaptor bnc coupler
CAAVI 1BM2BF	Cable adaptor bnc (m) -> 2 x bnc (f)
CAAVI 1CM1BF	Cable adaptor cinch (m) - bnc (f)
CAAVI DPDVI	Cable adaptor displayport -> dvi
CAAVI DVIVGA	Cable adaptor dvi-vga
CAAVI HDMIDVI	Cable adaptor hdmi -> dvi l=2m
CAAVI HDMIDVIL	Cable adaptor hdmi -> dvi l=5m
CAAVI HQHDMIDVI	Cable adaptor hdmi (f) - dvi (m)
CAAVI SCART1C	Cable adaptor scart -> cinch
CAAVI SCACENT	Cable adaptor scart -> component 3 x RCA - zonder audio
CAAVI SCACITS	Cable adaptor scart -> composite + audio
CAAVI SV2BNC	Cable adaptor s-video (m) -> 2 x bnc (f)
CAAVI CPLVGAF	Cable adaptor vga (f) -> vga (f) / gender
CAAVI VGA5BNCM	Cable adaptor vga (m) -> 5 x bnc (m)
CAAVI VGA5BNCF	Cable adaptor vga (m) -> 5 x bnc (f)
CAAVI CPLVGAM	Cable adaptor vga (m) -> vga (m) / gender
CAAVI IPAVGA	Cable adaptor Ipad dock - vga
CAAVI MOVSET	Set: MAC-overgangen
CAAVI MIPAVGA	Cable adaptor MAC Ipad dock - vga

Cables - Multi	
CAMUL AU4CH10	Cable audiomulti 4ch l=10m
CAMUL AU36H50	Cable audiomulti harting 36ch l=50m harting108p + power CEE 16A mono (m) -> shucko (f)
CAMUL BIH36	Cable break-in 36ch => harting 108p 32m + 4f
CAMUL AU8CH30	Cable audiomulti 8ch l=30m
CAMUL SBH36	Cable stageblock 36ch harting 108p => 36 xlr 32f + 4m
CAMUL AUSET	Set: audiomulti 50m Multi 36ch / Break-in / Break-out
CAMUL AU8S25	Cable audiomulti 8ch Socapex l=25m
CAMUL SBS08	Stageblock 8ch Socapex 25p => 8 xlr (m + f)
CAMUL AU8S25SET	Set: audiomulti 8ch Socapex l=25 1 x multi + 2 x stageblock
CAMUL BNC5CH02	Cable bncmulti 5ch l=2m
CAMUL BNC5CH05	Cable bncmulti 5ch l=5m
CAMUL BNC7CH15	Cable bncmulti 7ch l=15
CAMUL BNC7CH25	Cable bncmulti 7ch l=25m
CAMUL BNC8CH50	Cable bncmulti 8ch l=50m / haspel
CAMUL VID50	Cable videomulti l=50m 2ch xlr + HS-SDI + shucko
CAMUL JBL05	Cable jblmulti l=5m xlr + eurostroom
CAMUL JBL10	Cable jblmulti l=10m xlr + eurostroom
CAMUL JBL15	Cable jblmulti l=15m xlr + eurostroom
CAMUL DMX01	Cable dmxmulti l=1m 3pin + powercon
CAMUL DMX02	Cable dmxmulti l=2m 3pin + powercon
CAMUL DMX05	Cable dmxmulti l=5m 3pin + powercon
CAMUL LIGHT	Cable lightmulti l=100m 4 x dmx 5-pin (3p conn.) + shucko
CAMUL SP305	Cable sp3multi l=5m 2ch xlr + CEE 16 mono
CAMUL SP310	Cable sp3multi l=10m 2ch xlr + CEE 16 mono
CAMUL SP315	Cable sp3multi l=15m 2ch xlr + CEE 16 mono
CAMUL SP325	Cable sp3multi l=25m 2ch xlr + CEE 16 mono

**alfacode****Product****Cables - Harting**

CAHAR 10P02	Cable harting 10p l=2m
CAHAR 10P05	Cable harting 10p l=5m
CAHAR 10P10	Cable harting 10p l=10m
CAHAR 10P15	Cable harting 10p l=15m
CAHAR 10P25	Cable harting 10p l=25m
CAHAR 16P05	Cable harting 16p l=5m
CAHAR 16P10	Cable harting 16p l=10m
CAHAR 16P15	Cable harting 16p l=15m
CAHAR 16P25	Cable harting 16p l=25m

**Cables - Adaptor harting**

CAAHA SHH10	Cable adaptor shucko (m) -> harting 10p (f) / breakin
CAAHA H10BRIN	Cable adaptor 4 x shucko (m) -> harting 10p (f) / breakin
CAAHA H16BRIN	Cable adaptor 8 x shucko (m) -> harting 16p (f) / breakin
CAAHA H10BO4	Cable adaptor harting 10p (m) -> 4 x shucko + harting link / breakout
CAAHA H10BO5	Cable adaptor harting 10p (m) -> 5 x shucko + harting link / breakout
CAAHA H16BO	Cable adaptor harting 16p (m) -> 8 x shucko / breakout
CAAHA HOIST	Cable adaptor harting 16p (m) -> 4 x CEE 16A (f) / hoistspider
CAAHA H16MH10F	Cable adaptor harting 16p (m) -> harting 10p (f)
CAAHA H16SPLIT	Cable adaptor harting 16p -> 2 x harting 10p (f)
CAAHA H10INV	Cable adaptor harting 10p invers

**Cables - CEE**

CACEE 16A10	Cable CEE 16A l=10m
CACEE 16A15	Cable CEE 16A l=15m
CACEE 32A05	Cable CEE 32A l=5m
CACEE 32A10	Cable CEE 32A l=10m
CACEE 32A15	Cable CEE 32A l=15m
CACEE 32A25	Cable CEE 32A l=25m
CACEE 32A50	Cable CEE 32A l=50m
CACEE 63A02	Cable CEE 63A l=2m
CACEE 63A05	Cable CEE 63A l=5m
CACEE 63A10	Cable CEE 63A l=10m
CACEE 63A15	Cable CEE 63A l=15m
CACEE 63A25	Cable CEE 63A l=25m
CACEE 125A05	Cable CEE 125A l=5m
CACEE 125A15	Cable CEE 125A l=15m
CACEE 125A25	Cable CEE 125A l=25m
CACEE CE16MHAR10	Cable adaptor 16A 5P (m) -> Harting 10P

**Cables - Adaptor CEE**

CAACE SH16A	Cable adaptor shucko (m) -> CEE 16A mono (f)
CAACE CE16BM32F	Cable adaptor 16A blue (m) -> 32A (f)
CAACE 16ASH	Cable adaptor CEE 16A mono (m) -> shucko (f)
CAACE SH16M32F	Cable adaptor shucko (m) -> CEE 32A (f)
CAACE 16ASPIN2	Cable adaptor CEE 16A mono (m) -> 2 x CEE 16A mono (f)
CAACE 16ASPIN4	Cable adaptor CEE 16A mono (m) -> 4 x CEE 16A mono (f)
CAACE CE16M32F	Cable adaptor CEE 16A (m) -> CEE 32A (f)
CAACE CE32M324P	Cable adaptor CEE 32A (m) -> 32A 3P + aarding (f)
CAACE CE32M63F	Cable adaptor CEE 32A (m) -> CEE 63A (f)
CAACE CE63PT	Cable adaptor CEE 63A (f) (aansluiting met Cableschoen)
CAACE CE63M32F	Cable adaptor CEE 63A (m) - CEE 32A (f)
CAACE CE63M232F	Cable adaptor CEE 63A (m) - 2 x CEE 32A (f)
CAACE CE63SPLIT	Cable adaptor CEE 63A (m) - 2 x CEE 63A (f)
CAACE CE63M125F	Cable adaptor CEE 63A (m)- CEE 125A (f)
CAACE VYNCK16	Cable adaptor 16A 3P + A vynckier (m) -> CEE 16A (f)
CAACE VYNCK32	Cable adaptor 32A 3P + A vynckier (m) -> CEE 32A (f)

**Cables - Accessories**

CAACC CCO	Cable crossover 3x50x50 L=80cm
-----------	--------------------------------

## ALGEMENE VOORWAARDEN

### **Art. 1 TOEPASSINGSGBIED EN AFWIJINGEN:**

Onderhavige algemene voorwaarden zijn van toepassing op alle handelingen, diensten en overeenkomsten (zo ook op de occasionele verkoop van verbruiksgoederen en tweedehandsgoederen) met de verhuurder, met uitsluiting van de eventuele algemene voorwaarden van de huurder.

Door zijn bestelling erkent de huurder kennis te hebben genomen van onderhavige voorwaarden en deze zonder voorbehoud te aanvaarden. Afwijkingen hieraan, zelfs indien vermeld op onze documenten, zijn ons alleen dan tegenstelbaar als een van onze zaakvoerders ze schriftelijk heeft bevestigd. De eventuele nietigheid of ongeldigheid van een van deze voorwaarden brengt niet de nietigheid van de andere voorwaarden of van de overeenkomst teweeg. Het onderhavig contract geldt als bestelbon en bevestigt de persoonlijke verantwoordelijkheid van de ondertekenaar bij de afhaling of levering.

### **Art. 2 OFFERTES:**

De prijzen en voorwaarden op onze offertes zijn slechts geldig voor de duur van 1 maand. Alle offertes en prijsopgaven door of vanwege de verhuurder gedaan zijn steeds wederzijds vrijblijvend, behalve indien door de verhuurder schriftelijk anders is vermeld. Een huuroptie heeft een geldigheidsduur van 3 dagen.

### **Art. 3 AANVANG EN DUUR VAN DE OVEREENKOMST:**

De overeenkomst wordt geacht tot stand te zijn gekomen van zodra de huurder zijn bestelling, zij het mondeling of schriftelijk, van de te huren materialen plaatst bij de verhuurder en de verhuurder deze bestelling per kerende heeft bevestigd.

De duur van de huurovereenkomst wordt onderling en schriftelijk bepaald.

### **Art. 4 STAAT VAN HET MATERIAAL:**

De huurder erkent dat het door hem ontvangen materiaal in perfecte staat verkeert en goed functioneert. De huurder verklaart volledig te weten op welke wijze het materiaal moet worden gebruikt en verbindt zich ertoe dit met de uiterste zorg te gebruiken. Hij verplicht zich ertoe geen wijzigingen van welke aard ook aan het materiaal aan te brengen. Hij zal het materiaal ook enkel gebruiken voor het doel dat het gehuurd werd. In geval van defect is de verhuurder uitsluitend bevoegd om herstellingen of modificaties uit te voeren. Indien defecten zijn veroorzaakt door een nalatigheid van de huurder of te wijten aan een ongeval, worden deze herstellingskosten in rekening gebracht bovenop de huurprijs.

Wanneer bij de levering/installatie door de verhuurder zelf een defect materiaal wordt ontdekt dan kan de vervanging van het defecte onderdeel geen aanleiding geven tot de verbreking van de huurovereenkomst, noch kan dit als voorwendsel dienen voor een eis tot schadevergoeding of vermindering van het huurbedrag.

### **Art. 5 LEVERING EN LEVERINGSTERMIJN**

Behoudens andersluidende overeenkomst tussen partijen zijn de leveringstermijnen steeds bij benadering te interpreteren. De verhuurder verbindt er zich toe al het redelijke te doen ter naleving. Bij niet-naleving van de leveringstermijnen kan de huurder in geen geval schadevergoeding vorderen of overgaan tot ontbinding van de overeenkomst.

De huurder dient bij elke levering door Blue Moon van gehuurd materiaal aanwezig te zijn en na de levering de bestelbon af te tekenen.

Indien de huurder echter verzaakt aanwezig te zijn bij levering, erkent de huurder dat de goederen geleverd werden conform de bestelbon. Indien hierover betwisting bestaat, heeft de huurder steeds de mogelijkheid zulks onmiddellijk per fax en aangetekend schrijven te melden zolang de activiteit nog niet gestart is, waarvoor de huurder goederen gehuurd heeft bij Blue Moon.

Klachten omtrent het gehuurde materiaal dienen uiterlijk binnen de 3 dagen na de levering per fax en aangetekend schrijven te worden gemeld aan de verhuurder.



**Art. 6 VERLIES OF BESCHADIGING VAN HET MATERIAAL:**

De huurder draagt alle risico's, ook in geval van overmacht, voor het verlies van of schade toegebracht aan het gehuurde materiaal. De huurder ziet uitdrukkelijk af van elk verhaal tegenover de verhuurder in dit opzicht, welke ook de persoon moge zijn die een eis instelt.

De huurder is verplicht het gehuurde materiaal voor zijn rekening te laten verzekeren voor de nieuwprijs tegen elke vernieling of beschadiging van welke aard ook, alsmede tegen diefstal en/of handelingen door derden, materiaalbreuk, alle huurrisico's alsmede onbeperkte burgerlijke aansprakelijkheid. Indien zou blijken dat de huurder in gebreke is gebleven een verzekering af te sluiten zal de huurder hiervoor persoonlijk aansprakelijk worden gesteld.

De huurovereenkomst zal niet worden geschorst en zal volledig van kracht blijven in afwachting van reparatie of vervanging van het verloren gegane of gestolen materiaal. In geval van een ongeval of diefstal moeten de verzekeringsmaatschappijen de voorziene schadevergoedingen direct aan de verhuurder overmaken.

De huurder verplicht zich ertoe de verhuurder onmiddellijk te verwittigen per aangetekend schrijven indien het gehuurde materiaal geheel of gedeeltelijk:

- a) in beslag wordt genomen door derden. De huurder verplicht zich er tevens toe de beslagleggende partij te laten weten, dat het in beslag genomen materiaal aan de verhuurder toebehoort. In dit geval zullen de kosten van de procedure tot terugvordering van de in beslag genomen goederen volledig ten laste vallen van de huurder.
- b) zou betrokken zijn in een ongeval waardoor materiële schade of lichamelijke letsel is ontstaan of in een burgerlijke of strafrechtelijke procedure.
- c) om enigerlei andere reden zou worden opgevorderd, geleend, gestolen of beschadigd.

De huurder is hierbij verplicht een rechtsbijstandsverzekering af te sluiten. Alle kosten die hieruit voortvloeien zijn voor rekening van de huurder. Deze dient echter aan de verhuurder alle documenten en alle gegevens te verschaffen, die deze laatste noodzakelijk acht.

Indien de huurder geen eigenaar is van het pand waarin de gehuurde apparaten zijn ondergebracht, verplicht de huurder zich ertoe om de verhuurder op zijn verzoek de naam mede te delen van de eigenaar, of de bezoldigde, hypothecaire of bevoorrechte schuldeiser(s), opdat elke gebruikelijke kennisgeving aan hen kan worden gedaan.

**Art. 7 VRIJWARING VAN DE VERHUURDER VOOR AANSPRAKEN VAN DERDEN:**

De huurder is tevens aansprakelijk voor de schade geleden door derden ontstaan door het gebruik van het gehuurde materiaal en zal de verhuurder vrijwaren voor alle aanspraken dewelke derden hieromtrent richten aan de verhuurder.

**Art. 8 OVERSCHRIJDEN HUURTERMIJN:**

Wanneer de goederen niet strikt binnens de overeengekomen termijn worden teruggegeven, onverschillig om welke reden dan ook, heeft de verhuurder de keuze om bijkomend te factureren voor de overschreden periode dan wel zullen deze goederen beschouwd worden als te zijn verkocht en zal tegen de handelswaarde (nieuwprijs) worden gefactureerd. Bovenop de gefactureerde handelswaarde zal een gebruiksduur worden aangerekend voor de volledige duurtijd van het in bezit zijn van de gehuurde materialen door de huurder tot aan de aankoop van een vervangtoestel/materiaal.

De verhuurder zal ook de kosten aanrekenen die voortvloeien uit het niet tijdig teruggeven van de gehuurde materialen, d.w.z. bijvoorbeeld maar niet limitatief alle kosten (o.a. omzetverlies, gezichtsverlies, schadevergoedingen, ...) die de verhuurder lijdt door het mogelijk niet voorhanden hebben van materiaal door het te laat terugbrengen.

**Art. 9 TERUGGAVE VAN HET GEHURDE MATERIAAL:**

De huurder verplicht er zich toe het gehuurde materiaal terug te geven in de staat zoals beschreven in de bestelbon bij aanvang van de overeenkomst.

Alle ontbrekende onderdelen die bij de teruggave van het materiaal niet aanwezig zijn zullen als verkocht worden beschouwd en tegen de handelswaarde worden gefactureerd.

Bij het terugbrengen van huurgoederen kan de huurder eisen dat de goederen in zijn aanwezigheid worden nagezien en dat er samen een staat van eventuele schade kan worden opgesteld; deze staat wordt in dubbel opgesteld en door beide partijen ondertekend. Beide partijen ontvangen hiervan één exemplaar.

Indien de huurder afziet van deze gezamenlijke opstelling, gaat hij akkoord met de eventuele staat van schade die door Blue Moon eenzijdig zal worden opgesteld bij nazicht van de goederen.

**Art. 10 ANNULATIE DJ:**

Bij bestelling van een DJ met of zonder professionele geluids- en lichtinstallatie zal bij annulatie tot 3 maanden vóór het evenement 25% van de overeengekomen prijs worden aangerekend uit hoofde van annulatievergoeding; tot 1 maand vóór het evenement tot 50% van de contractprijs en vanaf 30 dagen vóór het evenement zal de gehele contractprijs voldaan worden uit hoofde van annulatievergoeding.

**Art. 11 ANNULATIE HUUR:**

Annulatie van het gehuurde materiaal dient te gebeuren ten laatste 7 dagen vóór het tijdstip waarop het huurcontract in werking treedt d.m.v. een aangetekend schrijven. Ingeval van tijdige annulatie is de huurder aan de verhuurder een schadevergoeding van 50% van de overeengekomen prijs verschuldigd. Bij laattijdige annulatie is de volledige huurprijs verschuldigd.

**Art. 12 BETALING/KLACHTEN/BEVOEGDHEID:**

Onze verhuringen worden beschouwd als dienstverlening aan de klanten en dienen kontant te worden betaald bij ophaling door de huurder of bij de levering door de verhuurder, tenzij anders vermeld op de offerte.

Alle facturen zijn betaalbaar op het adres van de zaak of door overschrijving op onze bankrekening. In geval van niet-betaling binnen de 15 dagen na factuurdatum zal van rechtswege en zonder enige ingebrekestelling een intrest verschuldigd zijn van 1% per maand. Iedere begonnen maand wordt ook als een volledige maand beschouwd.

Bij gebreke van betaling op de vervaldag zal het bedrag van de factuur van rechtswege verhoogd worden met 10% ten titel van schadevergoeding, en dit met een minimum van 150 EUR.

Indien één factuur niet betaald is binnen betalingstermijn worden alle (ook niet vervallen) facturen integraal opeisbaar.

Prestaties gefactureerd aan een buitenlandse firma binnen de EG zijn BTW vrijgesteld en dit ingevolge artikel 21§3,7° van het Belgisch Wetboek B.T.W.

Animaties zijn vrijgesteld van B.T.W.

Klachten omtrent de facturen dienen ons gemeld te worden per aangetekend schrijven en ten laatste 8 dagen na factuurdatum.

In geval van betwisting is uitsluitend de Rechtbank van Antwerpen bevoegd, en indien de betwisting tot de exclusieve bevoegdheid behoort van het Vrederegerecht, zal de Vrederechter van het 5<sup>de</sup> Kanton te Antwerpen de zaak beslechten.